

Relação do aço

ACO	N	DIAM	Q	UNIT	C. TOTAL (kg)
CA60	1	5.0	532	80	42560
	2	5.0	362	100	36200
	3	5.0	621	24	14904
	4	5.0	207	24	4968
	5	5.0	207	24	4968
	6	5.0	54	140	7560
	7	5.0	96	120	11520
	8	5.0	23	110	2530
	9	5.0	27	100	2700
	10	5.0	166	317	52622
CA50	11	10.0	20	390	7800
	12	10.0	20	390	7800
	13	10.0	20	390	7800
	14	16.0	6	317	1902

Resumo do aço

ACO	DIAM	C. TOTAL (m)	PESO * 10 % (kg)
CA50	10.0	602.3	408.4
	16.5	1.3	18.1
	16.5	1.3	18.1
	16.5	1.3	18.1
CA60	5.0	1264.4	217.8
PESO TOTAL			
CA50	622.6		
CA60	217.8		



TABELA DE COBRIMENTOS

LAYER	SUPERIORE	INTERIOR	INFERIOR
NOZ	2.50 cm	2.50 cm	2.50 cm
PLACAS	2.50 cm	2.50 cm	2.50 cm
BEIÇOS	2.50 cm	2.50 cm	2.50 cm
ESCORTE	4.00 cm	4.00 cm	4.00 cm

DETALHES IMPORTANTES DE PROJETO

- Dimensões em centímetros (cm).
- Diâmetro das barras de aço em milímetros (mm).

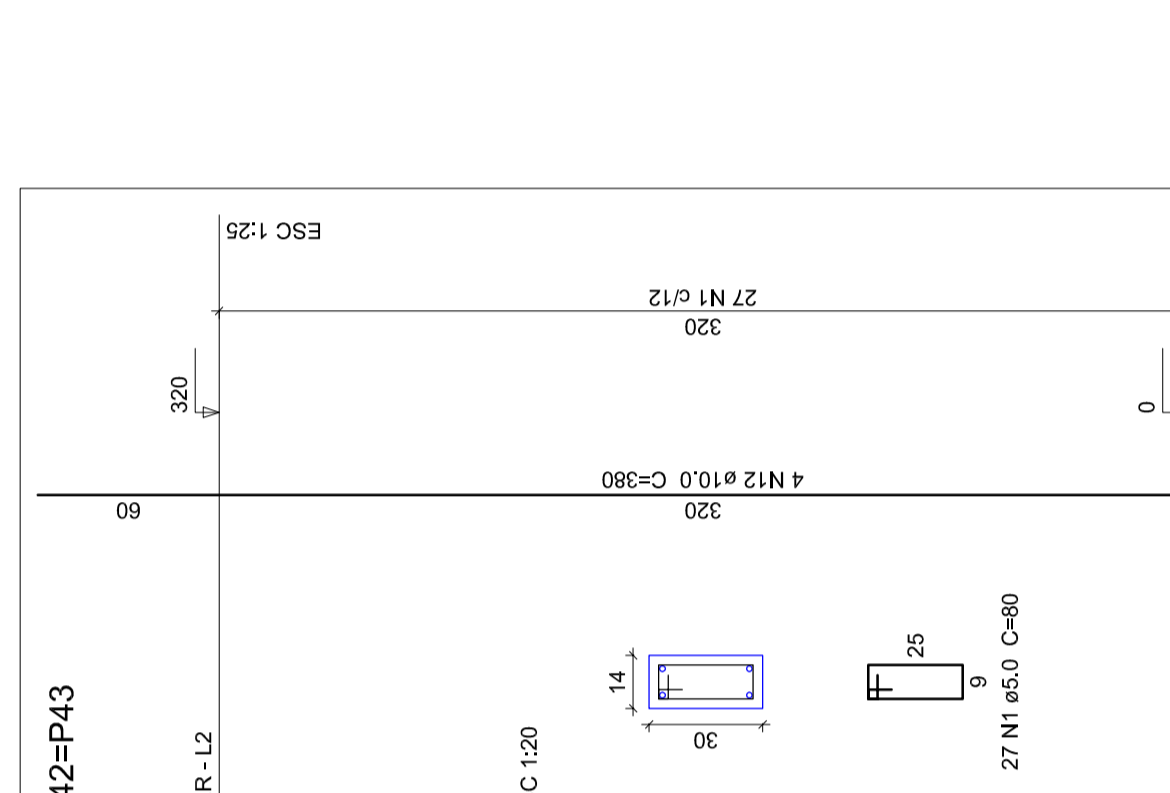
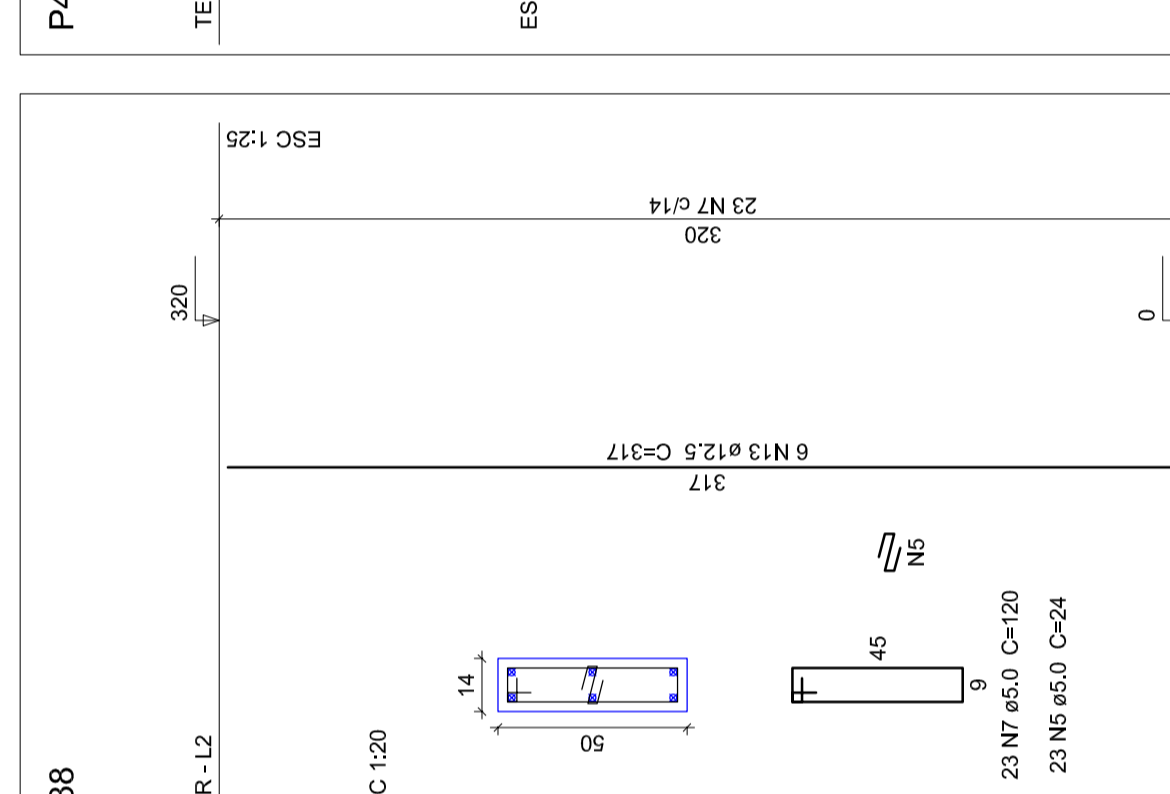
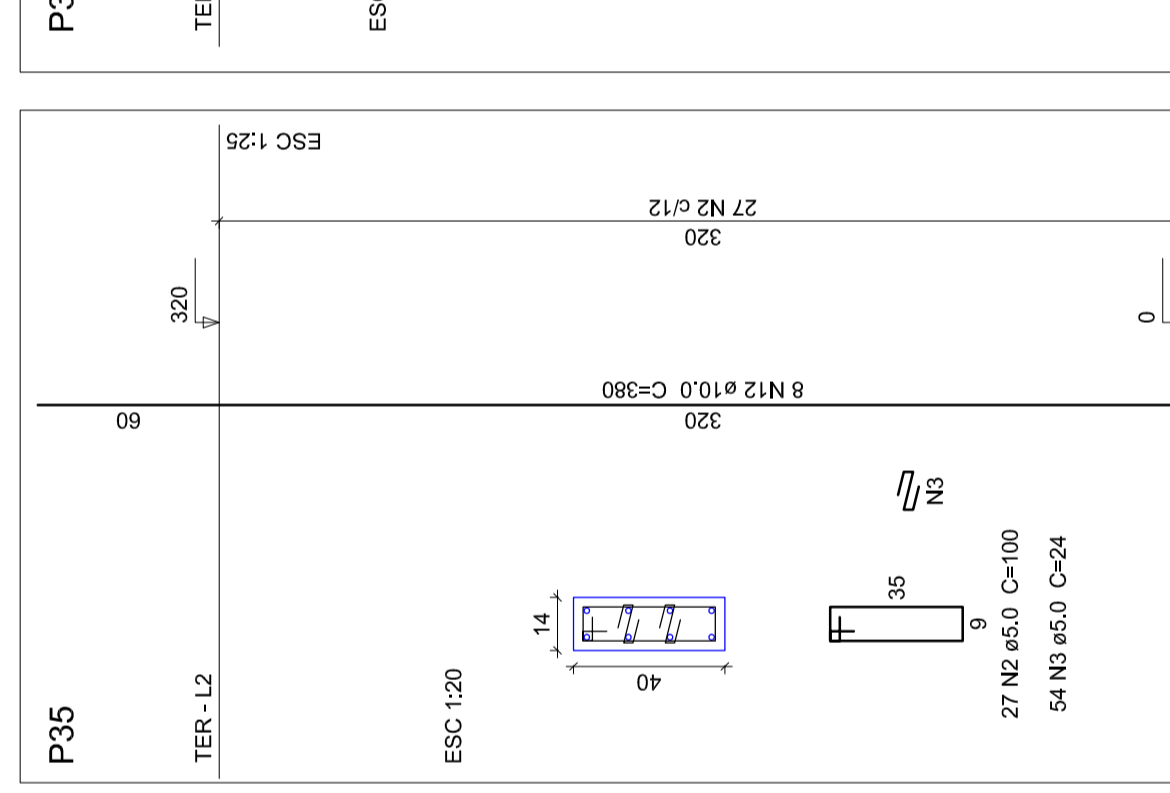
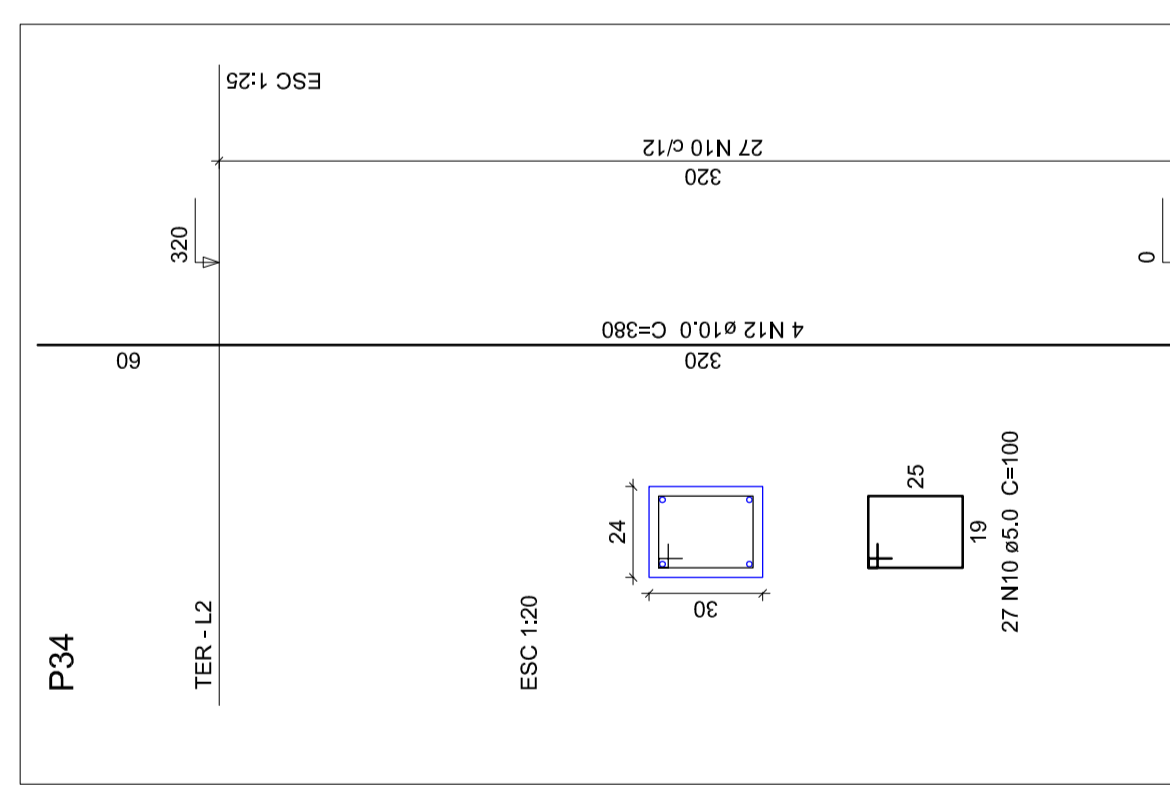
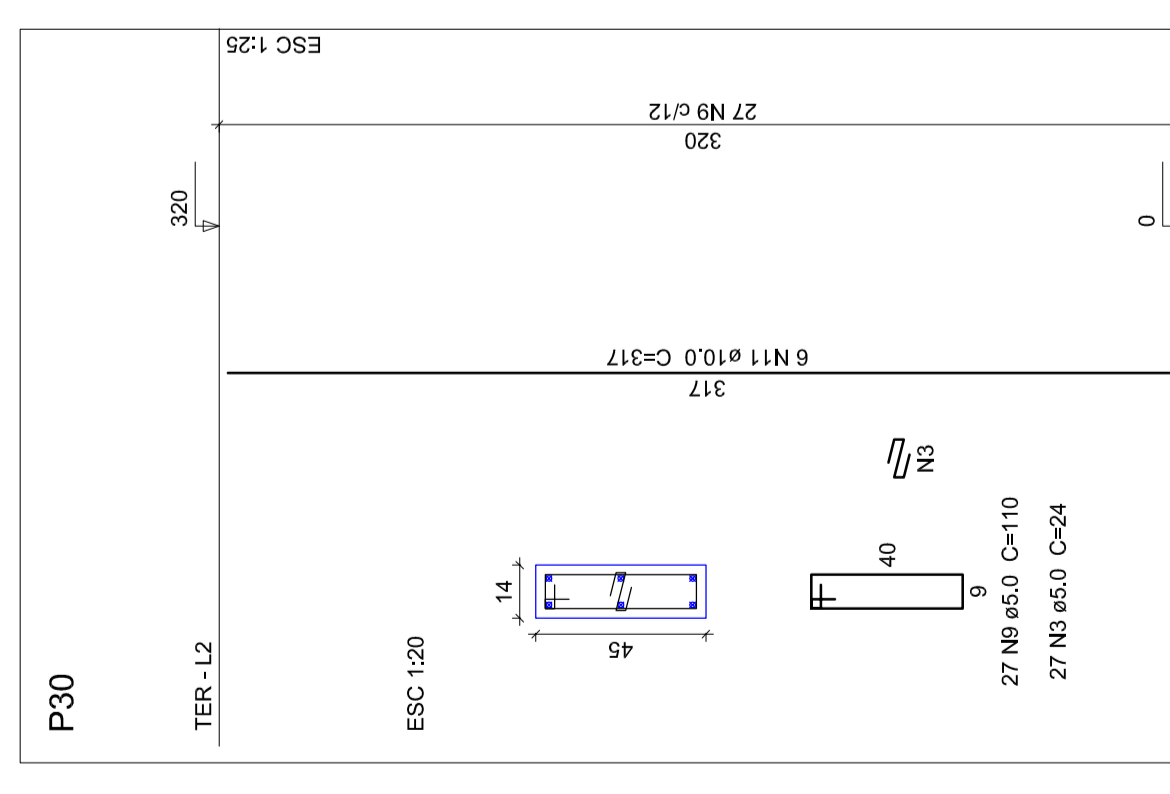
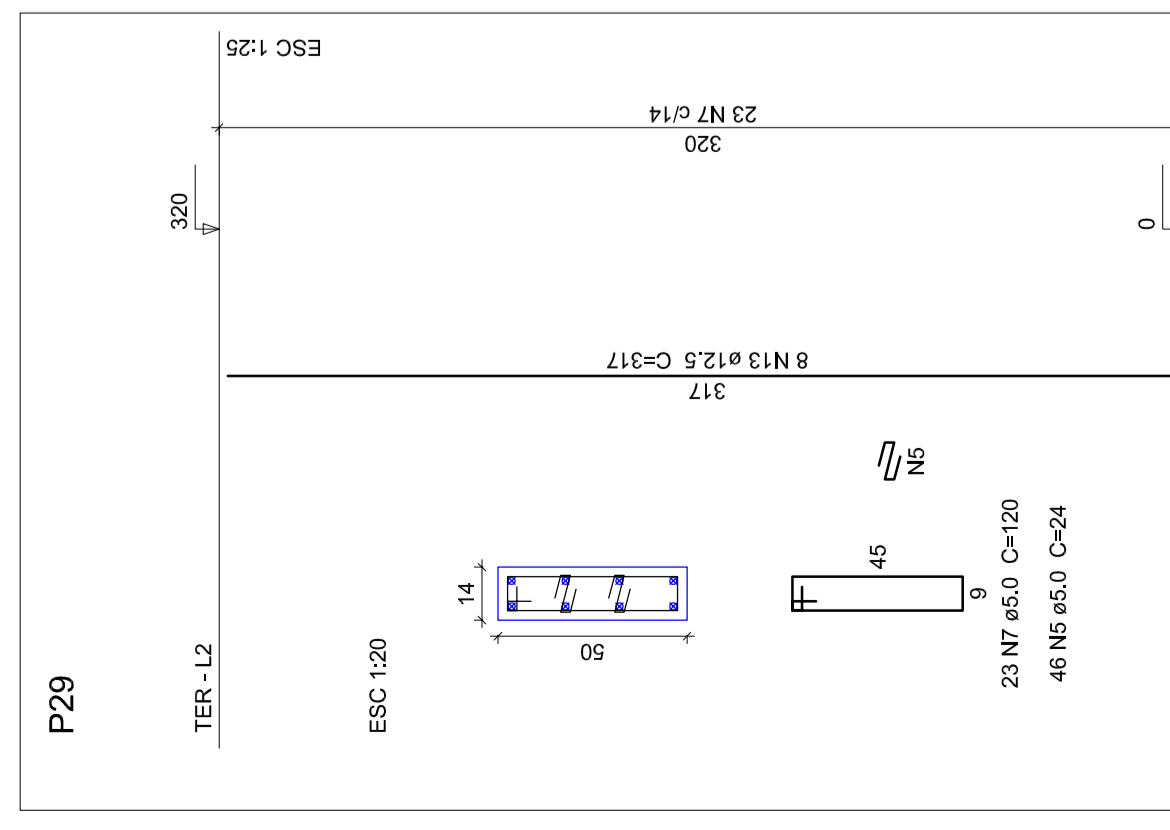
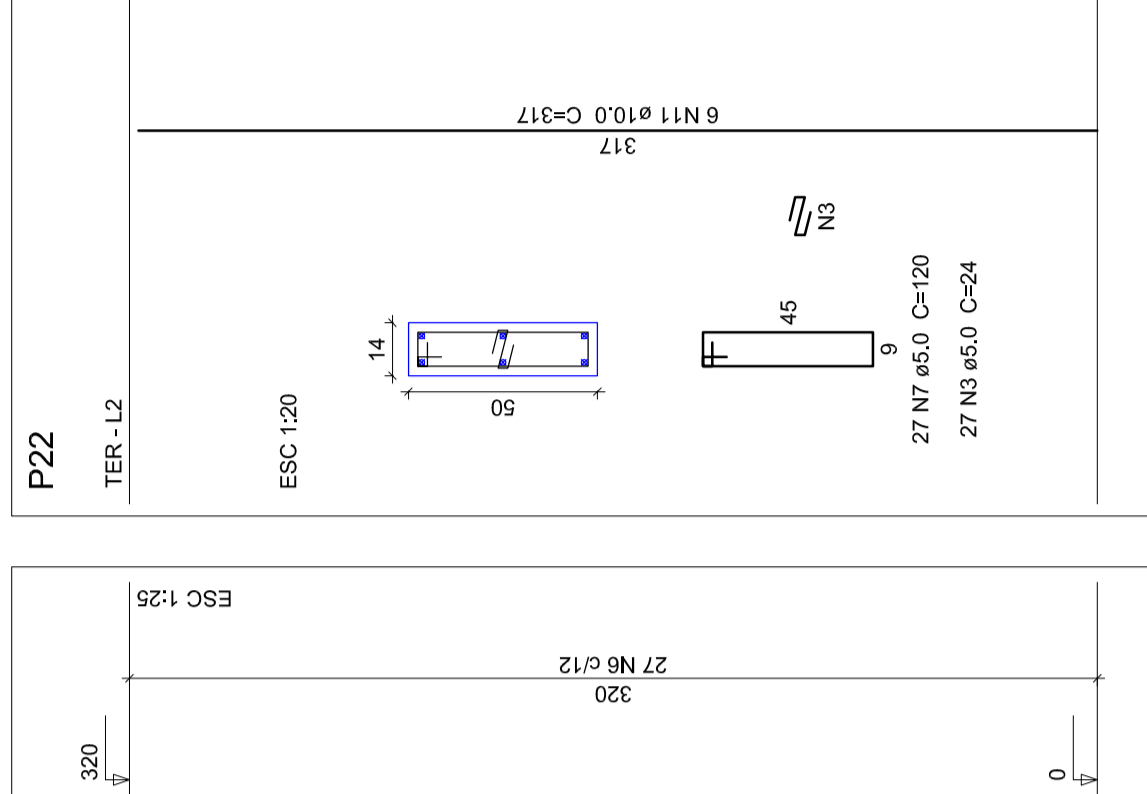
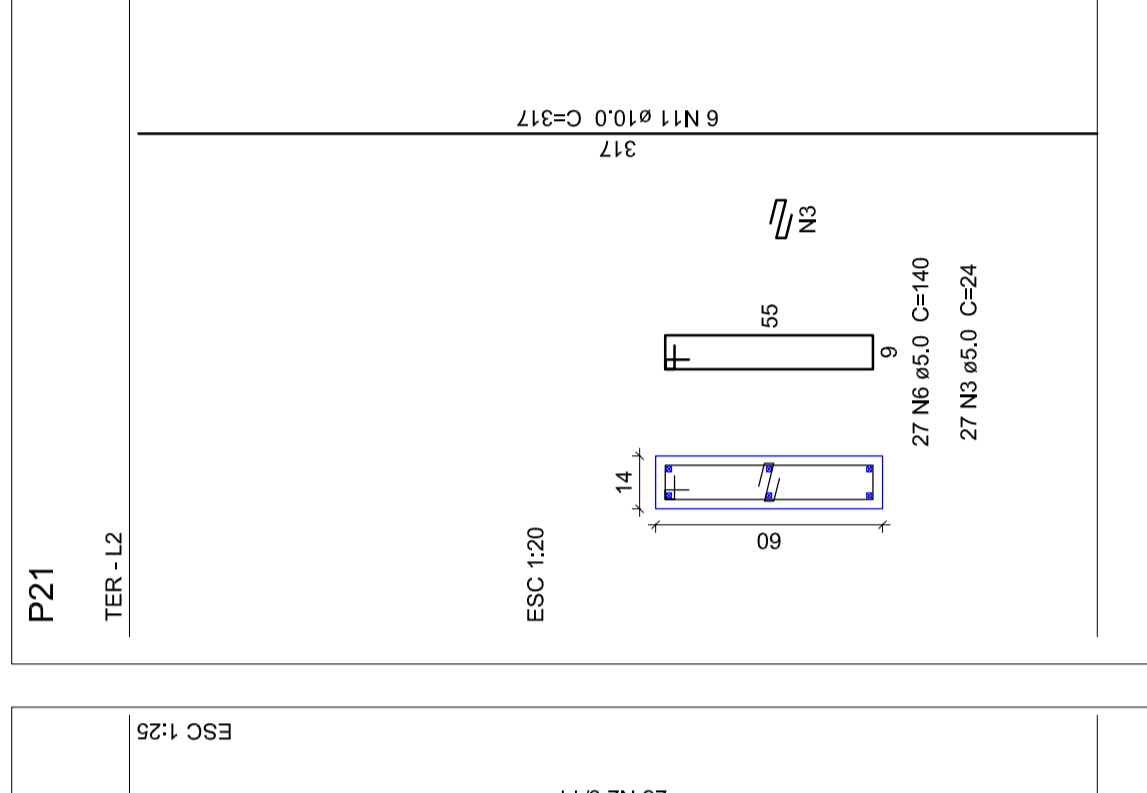
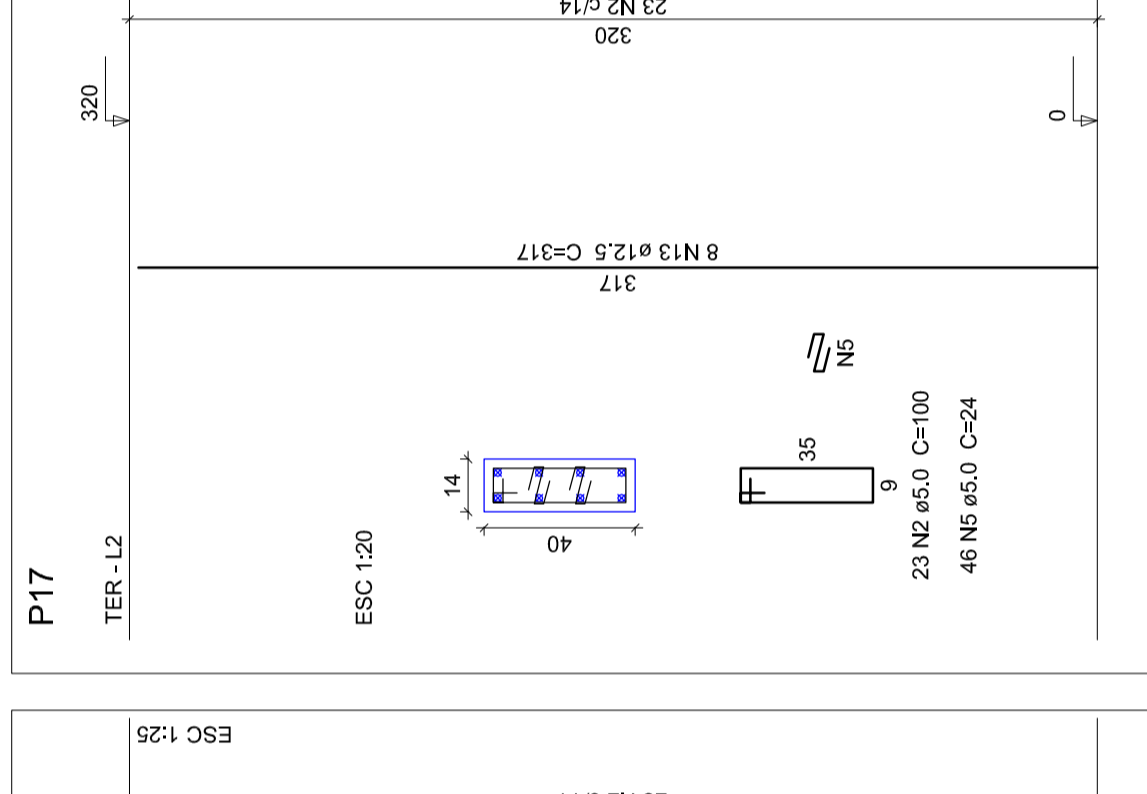
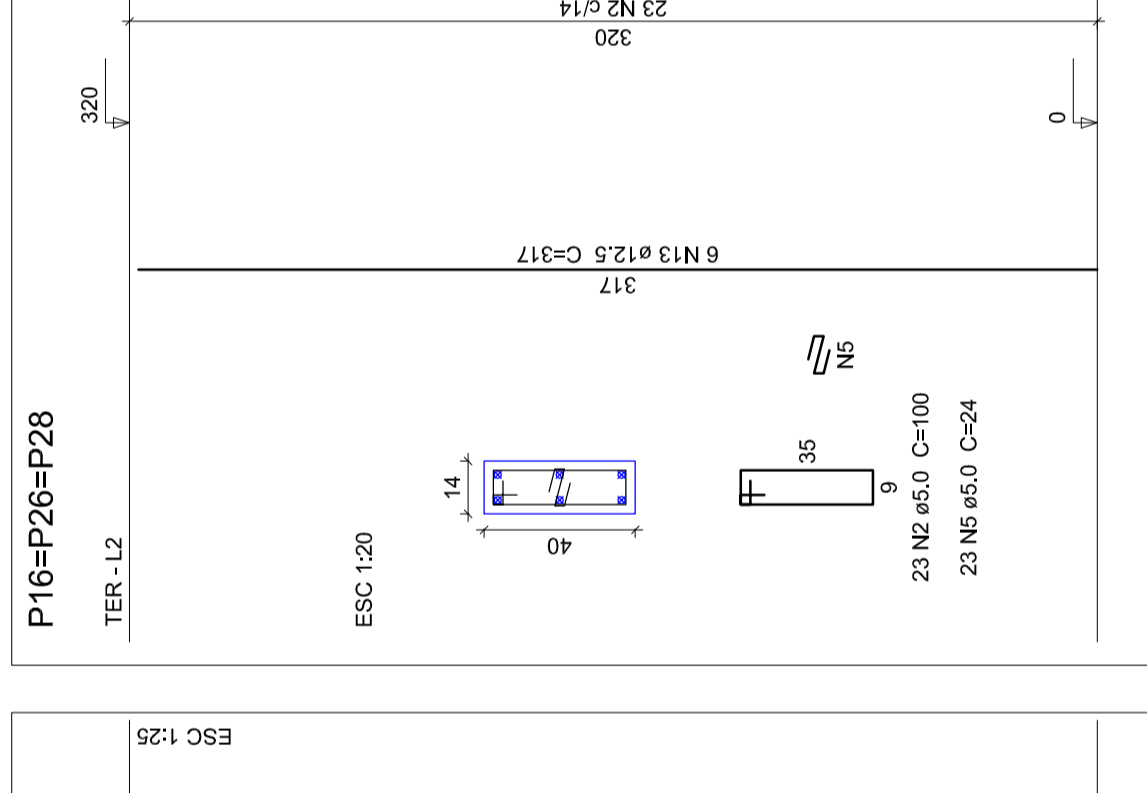
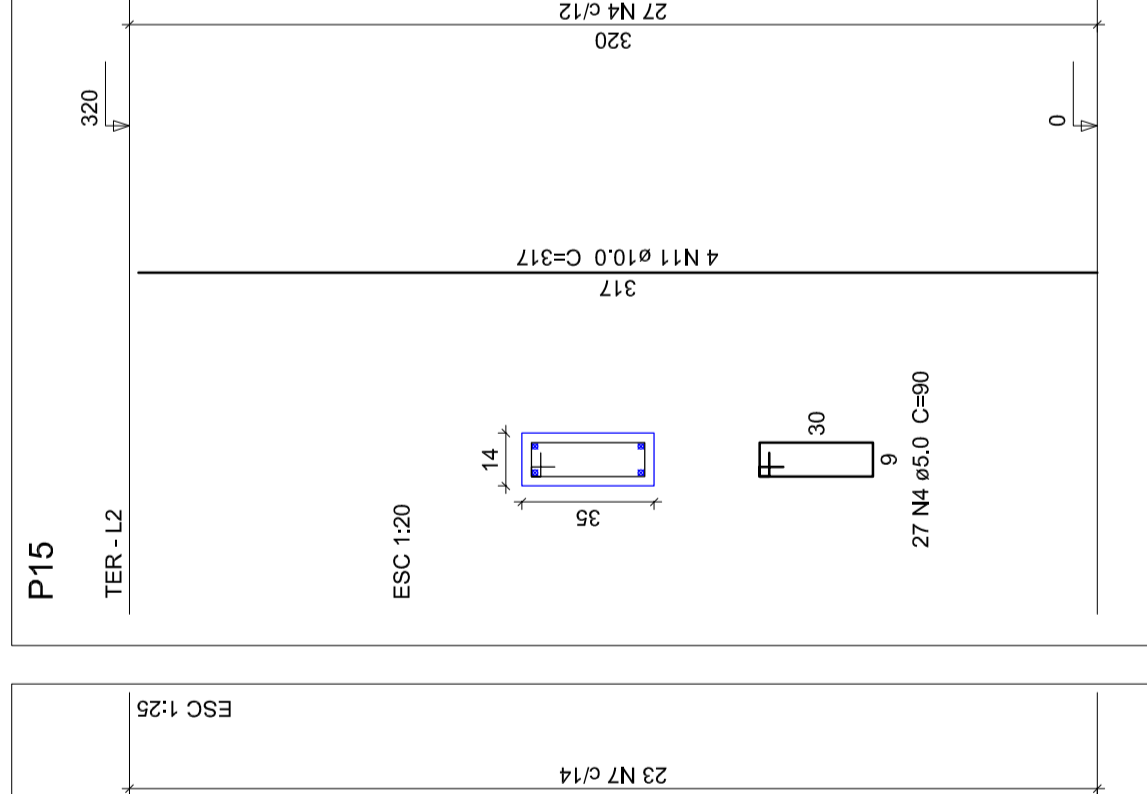
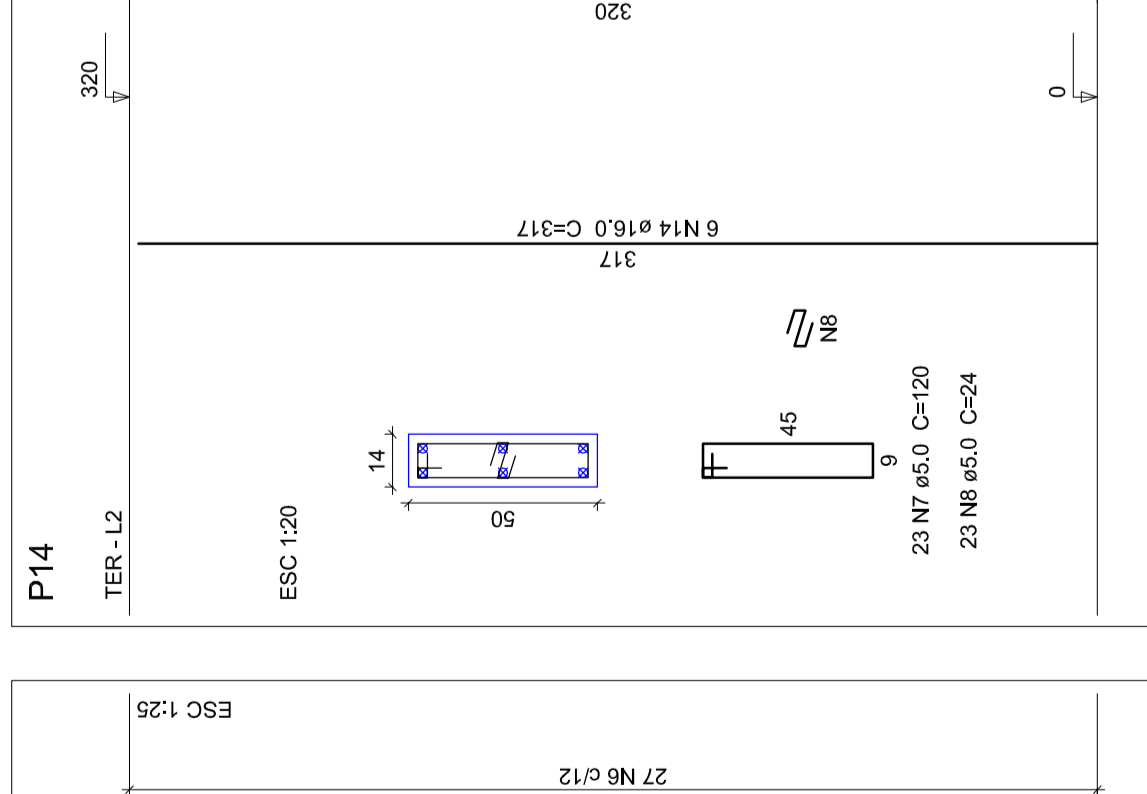
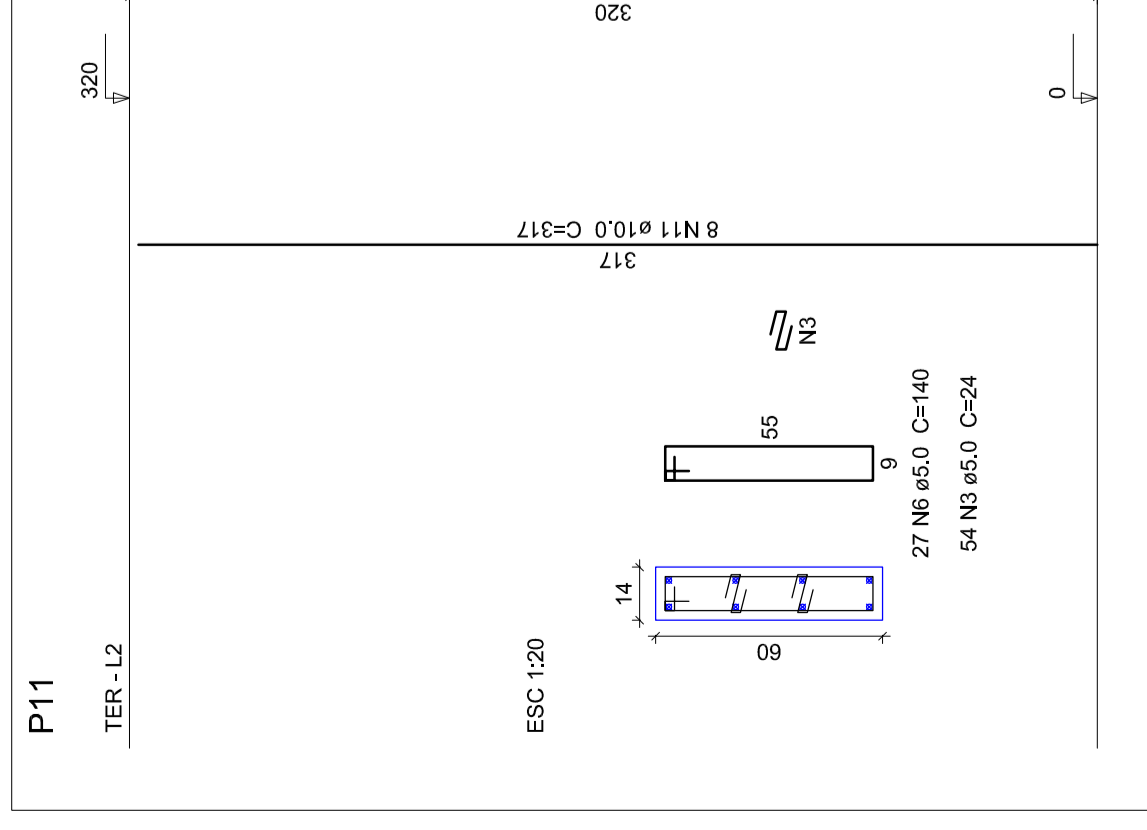
INSTRUÇÕES:

- Usar espaçadores plásticos para garantir o cobrimento.
- Usar medidas antes da concretagem.
- Evitar o uso de barras de aço com defeitos de fabricação.
- Evitar excessivo de água além da mistura no concreto.

ESPECIFICAÇÕES:
CONCRETO CLASSE C-25 → **FCk:25 Mpa**

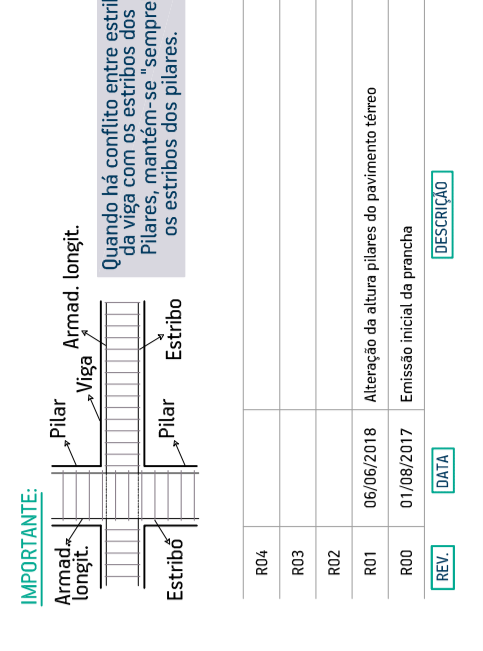

PROJETO: ESTRUTURAL - EST - DWG - 2.TÉRREO

EMPREENHADOR: RUA REINALDO SARAIEDOTTO, QUADRA 29, PARTE DOS LOTES 05, 06 E 07 - CENTRO - SERTÃOZOS

PROPRIETÁRIO: PREFEITURA MUNICIPAL DE SERTÃO ZOIROSÓZOS ENGENHARIA

DISCIPLINA: DETALHAMENTO DE PILARES - LANCE 2 - Pav. Térreo

ÁREA CONSTRUTIVA: 394,41 m² **ESCALA:** 1:20 **PARCELA:** 11

CÓDIGO: 1719 **REVISÃO:** 001 **DATA:** DEZ/2017 **EST:** 06

OBSERVAÇÕES: Direitos autorais reservados conforme artigo 184 do código civil, contra 205/71

Edição Revisão
Francisco Reinaldo Saraiedotto 17/2017 01
54 9166.5893

Edição Revisão
Mário André Berni 06/2018 01
54 9166.5893